



Verschlüsse und Befestigungen



Schnellverschluss-Oberteil
mit kleinem Kopf
15 mm hoch
M60-1 Ms vernickelt
M60-2 Ms verchromt



Schnellverschluss-Oberteil
mit großem Kopf
15 mm hoch
M60-3 Ms vernickelt
M60-4 Ms verchromt
M60-31 Ms Edelstahl



M60-7
Schnellverschluss-
Stoffunterteil
Ms verchromt



M60-27
Schnellverschluss-Unterteil
für 3,5 mm Linsensenk-
schrauben
Lochabstand 15,1 mm
Ms/St verchromt



M60-13
Schnellverschluss-
Unterteil
Blechschaube
4,2 x 12 mm verchromt



M60-14
Schnellverschluss-
Unterteil
Blechschaube
4,2 x 16 mm vernickelt



Schnellverschluss-Unterteil
Blechschaube 4,2 x 16 mm
hoher Kopf
M60-19 vernickelt
M60-20 verchromt



Schnellverschluss-Unterteil
Gewindeschraube
M60-24 M5 x 10 mm verchromt
M60-66 M5 x 25 mm Edelstahl



Schnellverschluss-Unterteil
hoher Kopf
Gewindeschraube M5 x 10 mm
M60-21 vernickelt
M60-22 verchromt
M60-35 Edelstahl

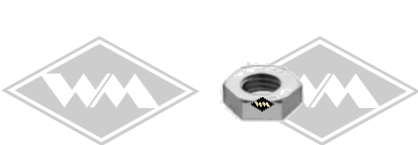

Mutter
M69-2 M5 Edelstahl
M69-3 M5 Ms vernickelt



M60-36
Schlüssel



**Andere Schnellverschluss-Ausführungen
(Abmessungen, Material) auf Anfrage!**



M2-1
Fix-Verschluss Oberteil
2-tlg.



M2-3 Kegel
Fix-Verschluss Unterteil
2 Tuch Gewindeschraube
Stoff/Metall, Kopf 13 mm hoch



M2-5 Kegel
Fix-Verschluss Unterteil
1 Tuch Holzschraube
selbstschneidend
Stoff/Holz, Kopf 10 mm hoch



M2-7 Kegel
Fix-Verschluss Unterteil
2 Tuch Holzschraube
selbstschneidend
Stoff/Holz, Kopf 14 mm hoch



M2-8 Kugel
Fix-Verschluss Unterteil
2 Tuch Holzschraube
selbstschneidend
Stoff/Holz, Kopf 16 mm hoch



M2-9 Kugel
Fix-Verschluss Unterteil
1 Tuch Stoffniet



M3-1
Druckknopf
Kappe-Öse-Kugel-Niet
Messing vernickelt

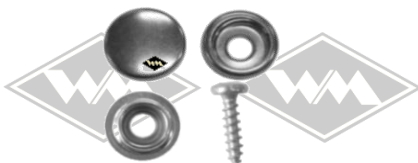

Druckknopf
Kappe-Öse-Kugel-Schraube
M3-2 Messing vernickelt
M3-3 Messing brüniert (schwarz)



M4
Teppichdruckknopf
4-tlg.

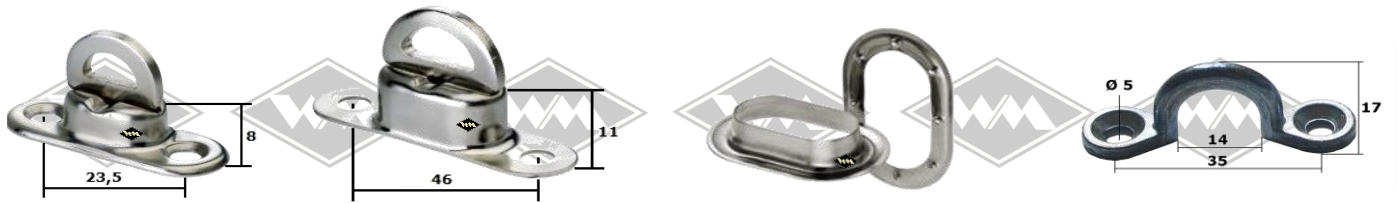

M70
Drehverschluß klein

M71
Drehverschluß groß

Ovalöse + Scheibe
M72-1 17 x 11 mm (für M70)
M72-2 22,5 x 13,5 mm (für M71)

Posamenten-Krampe
M56-1 vernickelt
M56-2 verchromt

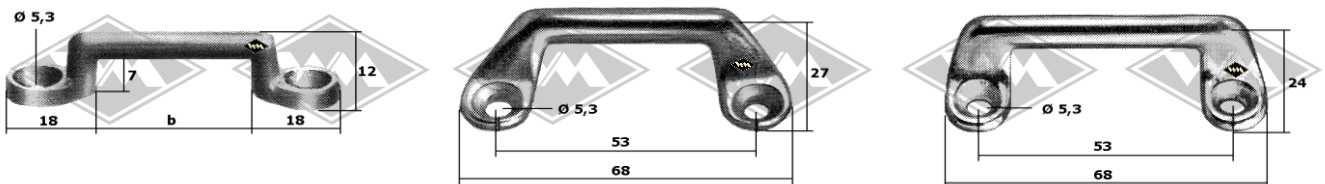

Lakai-Krampe vernickelt
M51 b = 25 mm

Türhalter-Krampe
M53-1 schwarz lackiert
M53-2 verchromt

M55
Türhalter-Krampe verchromt

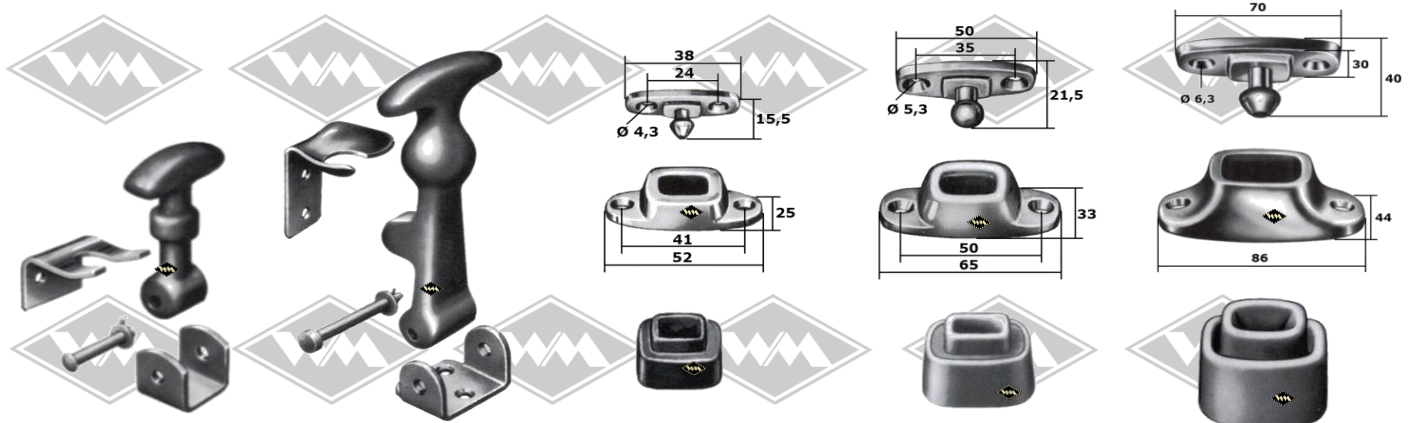

D94
Haubenhalter klein
Gummitteil 64 mm

D95
Haubenhalter groß
Gummitteil 125 mm

M75
Türfeststeller klein, 3-tlg.
(Puffer 19x22 mm)

M77
Türfeststeller mittel, 3-tlg.
(Puffer 30x26 mm)

M76
Türfeststeller groß, 3-tlg.
(Puffer 38x42 mm)

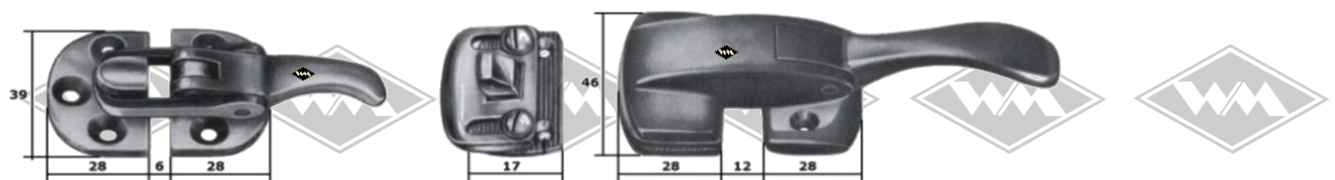

M73
Verdeckverschluß klein verchromt

M74
Verdeckverschluß groß verchromt

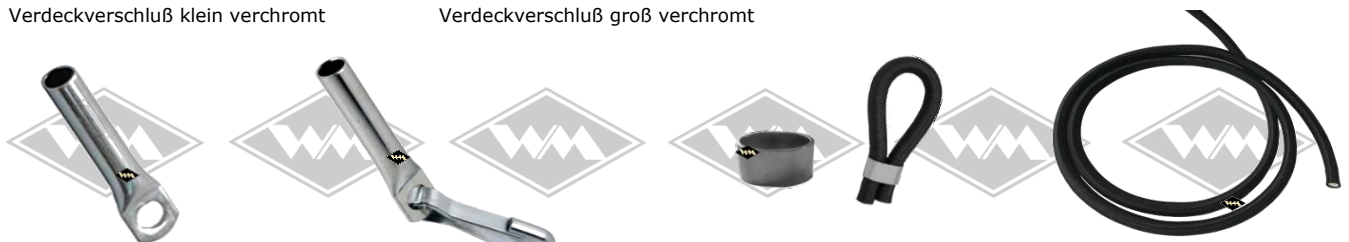

Seilendverschluss
für Expanderseil
M95 Ø 6 mm
M96 Ø 8 mm
M97 Ø 10 mm

Seilendverschluss mit Simplexhaken
für Expanderseil
M98 Ø 6 mm
M99 Ø 8 mm
M100 Ø 10 mm

Würgeklemme
für Expanderseil
M101 Ø 6 mm
M102 Ø 8 mm
M103 Ø 10 mm

Expanderseil
für Expanderseil
D10 Ø 6 mm
D11 Ø 8 mm
D12 Ø 10 mm

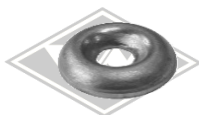

Unterlegscheiben
Hohlscheibe
Aluminium
(Ø innen / außen)
M27 3 / 11 mm (A3)
M28 4 / 14 mm (A4)
M29 5 / 16 mm (A5)
M31 8 / 24 mm (A8)



Unterlegscheiben
Hohlscheibe
Messing vernickelt
(Ø innen / außen)
M57 4,5 / 12 mm
M40 6 / 18,5 mm



Unterlegscheibe
Stoffschutzscheibe
Messing vernickelt
(Ø innen / außen)
M34 3 / 9 mm
M35 3,5 / 11 mm
M36 4 / 12,5 mm
M37 4,5 / 12,5 mm
M38 5 / 14,5 mm



Zylinderblechschraube
Stahl verzinkt, Schlitzschraube
(Ø Schraubenschaft / Länge)
M62-1 2,9 / 13 mm
M62-2 2,9 / 16 mm
M62-3 3,5 / 13 mm
M62-4 3,5 / 16 mm
M62-5 3,5 / 19 mm
M62-6 4,8 / 19 mm
M62-7 5,5 / 19 mm
M62-8 5,5 / 25 mm
M62-9 6,3 / 25 mm



Linsensenkblechschraube
Stahl verzinkt, Schlitzschraube
(Ø Schraubenschaft / Länge)
M62-10 2,9 / 9,5 mm
M62-11 3,5 / 13 mm
M62-12 3,5 / 16 mm
M62-13 3,5 / 19 mm
M62-14 3,9 / 13 mm
M62-15 3,9 / 19 mm
M62-17 3,9 / 32 mm
M62-18 3,9 / 38 mm
M62-20 4,8 / 13 mm
M62-21 4,8 / 19 mm
M62-22 4,8 / 25 mm



Zweispitznieten (Spreiznieten)
(Ø Hut / Länge)
M44 5,5 / 13 mm
M45 8 / 18 mm
M22 9,5 / 16 mm



Hohlriet (Calott)
(Ø Nietschaft / Ø Hut / Länge)
M5-1 4 / 7 / 8 mm (Original DDR)
M5-2 3 / 10 / 9 mm
M5-3 3 / 13 / 12 mm



Hohlriet (Doppel-Calott)
(Ø Nietschaft / Ø Hut / Länge)
M6-1 3 / 9 / 10
M6-2 3,5 / 13 / 15



Haltefeder
(Ø Hut x Länge)
M3800 14 / 25 mm
M4159 15 / 28 mm



M4157
Haltefeder



M311
Zierleistenfeder
Wartburg 311



M61
Türverkleidungsfeder
Wartburg 311



M4270
Türverkleidungsfeder



M3100
Haken



M4103
Polsterklammer
Höhe: 9 mm
Klemmbereich: 1,0 - 1,5 mm



M4275
Polsterklammer
Höhe: 8 mm
Klemmbereich: 2,3 - 2,6 mm



M20
Polsterklammer
20 mm

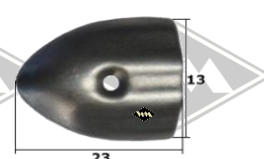

M7
Doppelkeder-Endspitze
Aluminium